

FMC-05

FM PANEL ANTENNA

FEATURES

- circular polarization
- broadband 87.5 ÷ 108 MHz
- 2.5 dB gain
- directional pattern
- suitable as a component in various arrays on triangular towers
- stainless steel dipoles

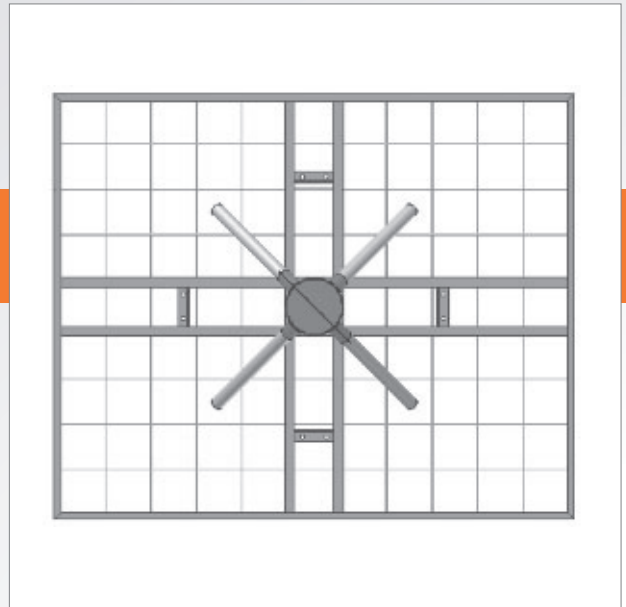

ELECTRICAL DATA

ANTENNA TYPE	FMC-05
FREQUENCY RANGE	87.5 ÷ 108 MHz
IMPEDANCE	50 ohm
CONNECTOR	2 x 7/8" EIA
MAX POWER	10 kW (5 kW per dipole)
VSWR	≤ 1.15 (in circular polarization)
POLARIZATION	Circular
GAIN (referred to half wave dipole)	2.5 dB (Circular polarization) 5.5 dB (Linear polarization)
HALF POWER BEAMWIDTH	Horizontal component: ± 38° Vertical component: ± 42°
LIGHTNING PROTECTION	All Metal Parts DC Grounded

MECHANICAL DATA

DIMENSIONS mm (in)	2200 x 1800 x 1134 (86.61 x 70.87 x 44.65)
WEIGHT kg (lb)	82 (181)
WIND SURFACE m ² (ft ²)	1.73 (18.6) front 1.12 (12.1) side
WIND LOAD kN (lbf) at 160 km/h (100 mph)	2.14 (481) front 1.37 (308) side
MAX WIND VELOCITY km/h (mph)	220 (136.7)
MATERIALS	Reflector (hot dip galvanized steel) Dipoles (stainless steel) Internal parts (silver plated brass, polished brass) Radome (fiberglass)
ICING PROTECTION	Feed point radome
RADOME COLOUR	Grey (standard)
MOUNTING	Directly on supporting mast

RADIATION PATTERNS (Mid Band)

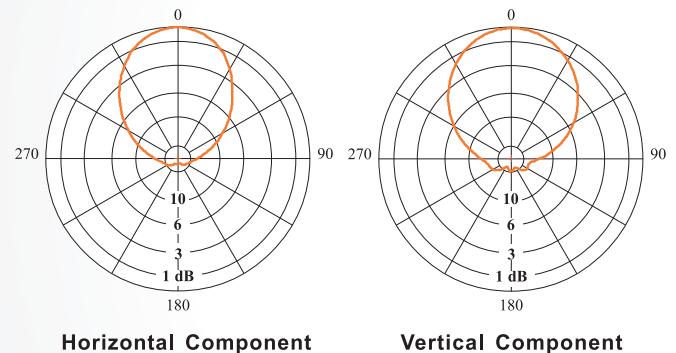

VSWR

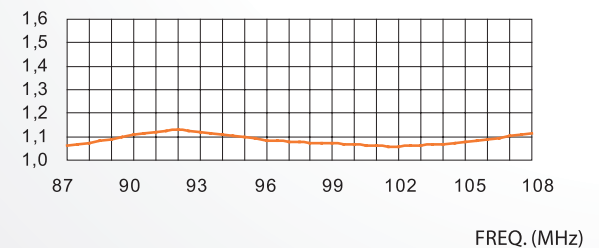

GAIN (dB)

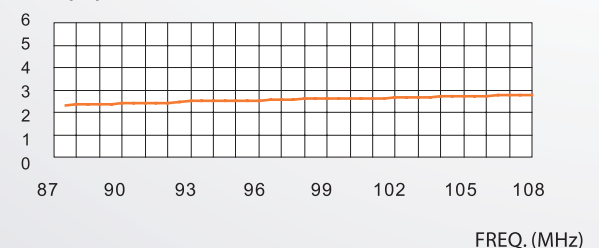

FMC-05

FM PANEL ANTENNA

FEATURES

- radiating systems with FMC-05 panel on triangular towers
- high power systems
- omnidirectional or directional patterns
- equal or unequal split ratio power distribution network
- broadband 87.5 ÷ 108 MHz

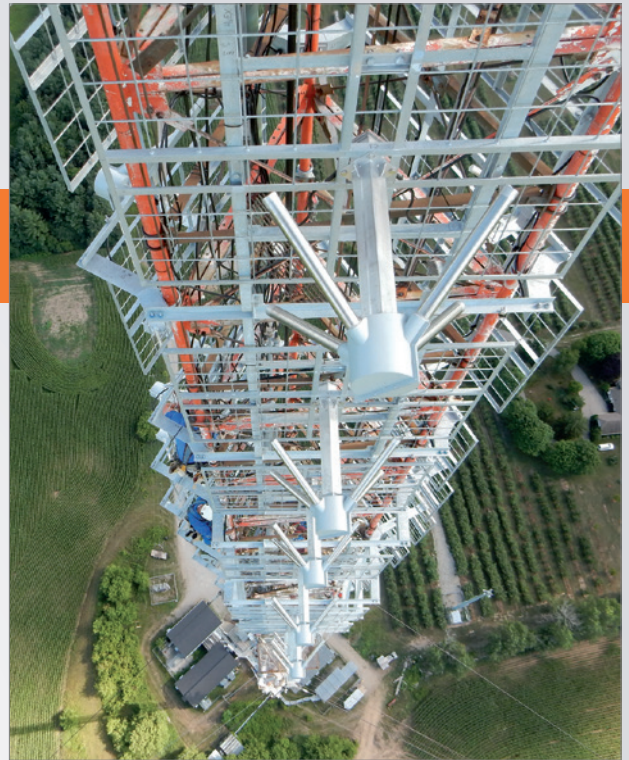

FMC-05
LONDON, ON (CANADA)

ELECTRICAL DATA

FREQUENCY RANGE	87.5 ÷ 108 MHz
IMPEDANCE	50 ohm
CONNECTOR	EIA flange according to system power rating
POWER RATING	The antenna system can accept any power according to requirements
VSWR	≤ 1.2 Throughout the frequency range (Lower figures for individual frequencies on request)
POLARIZATION	Circular / Elliptical on request
GAIN	Refer to table
HORIZONTAL PATTERN	Any type according to requirement
VERTICAL PATTERN	Null fill, beam tilt and special requirements to order
OTHER FEATURES	The antenna system can be supplied in split feed configuration (two equal halves) Each half can accept full power

MECHANICAL DATA

HEIGHT OF ARRAY	Subject to number of bays
TOTAL NET WEIGHT	Refer to table
WIND LOAD	Refer to table
PRESSURIZABLE	Yes
RADOME COLOUR	Grey (standard)
MOUNTING HARDWARE	Available upon request

FMC-05

FM PANEL ANTENNA

HORIZONTAL PATTERNS WITH 2 AND 3 FACES AT 98 MHz

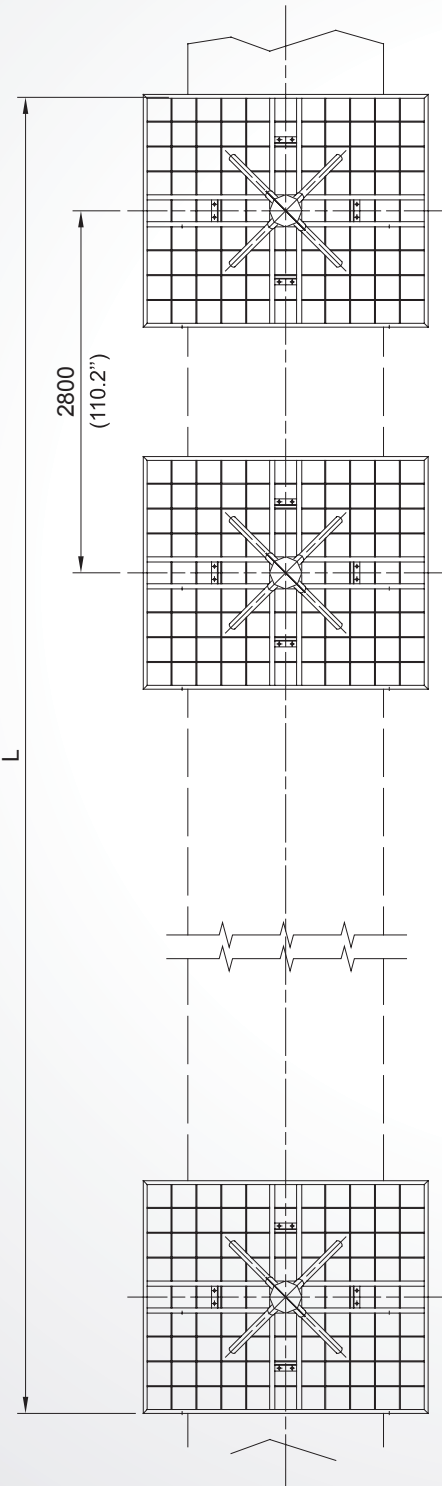
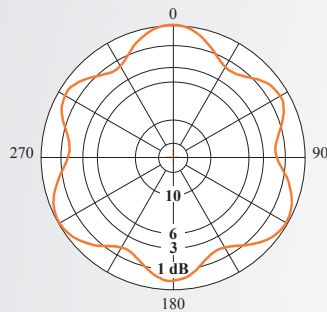
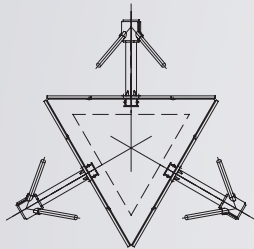
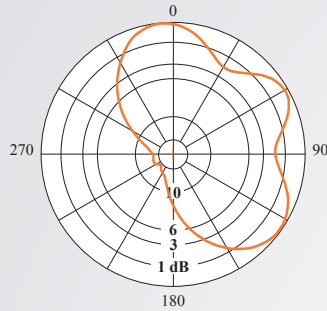
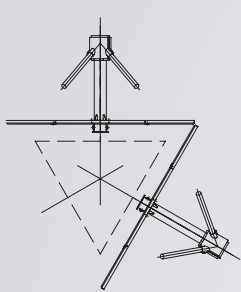

TECHNICAL DATA

NUMBER OF BAYS	PANELS PER BAY	GAIN dB (1)	GAIN TIMES (1)	WEIGHT (2) kg (lb)	ANTENNA HEIGHT L m (ft)	WIND LOAD (3) kN (lbf)
1	2	-0.4	0.91	192 (423)	1.8	2.68 (602)
	3	-2.2	0.60	278 (613)	(5.9)	2.90 (652)
2	1	5.6	3.63	192 (423)	4.6	2.93 (658)
	2	2.6	1.82	364 (802)	(15.1)	5.37 (1207)
	3	0.8	1.20	586 (1292)		5.80 (1304)
4	1	8.6	7.24	364 (802)	10.2	5.87 (1320)
	2	5.6	3.63	788 (1737)	(33.4)	10.74 (2414)
	3	3.8	2.40	1112 (2452)		11.60 (2608)
6	1	10.6	11.48	586 (1292)	15.8	8.80 (1978)
	2	7.6	5.75	1112 (2452)	(51.8)	16.11 (3622)
	3	5.8	3.81	1698 (3743)		17.40 (3912)
8	1	11.8	15.14	788 (1737)	21.4	11.74 (2639)
	2	8.8	7.59	1526 (3364)	(70.2)	21.48 (4829)
	3	7.0	5.01	2264 (4991)		23.21 (5218)

(1) referred to half wave dipole. Losses of power distribution network not included.

(2) without mounting hardware.

(3) v = 160 km/h (100 mph)

FMC-05

FM PANEL ANTENNA

DIMENSIONAL DETAILS

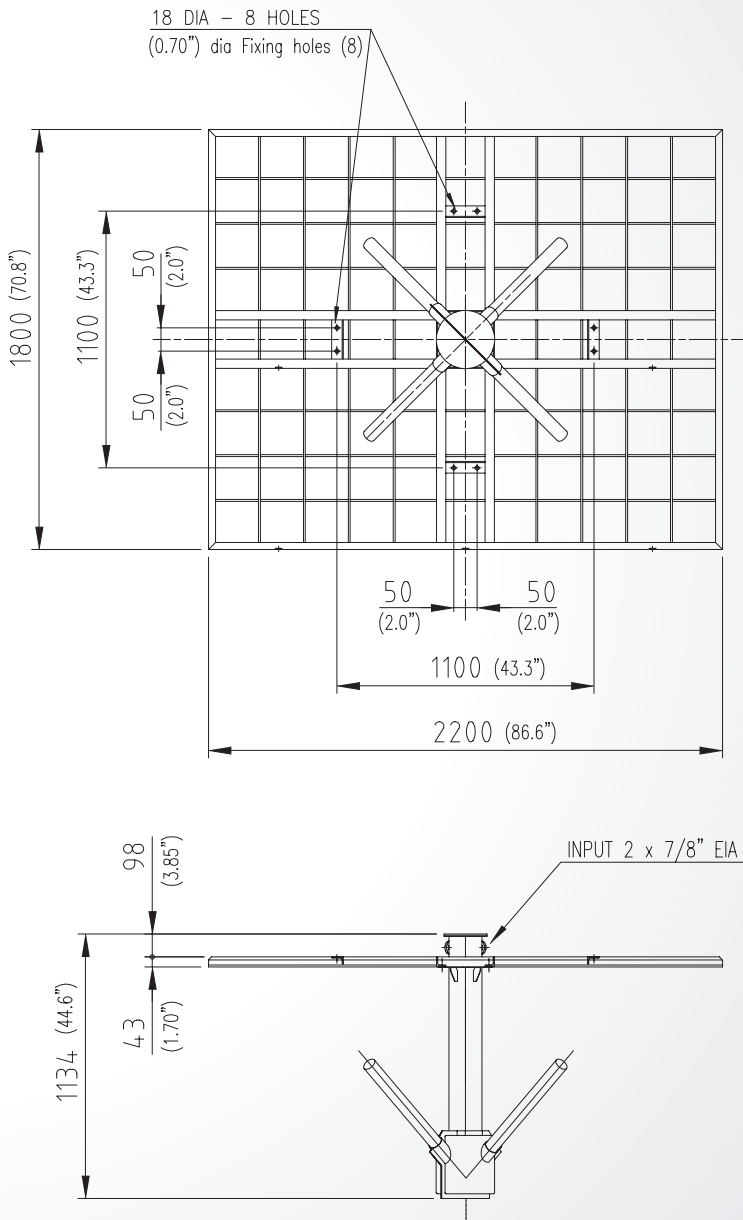

VERTICAL PATTERN

— Without null fill
— With null fill and beam tilt

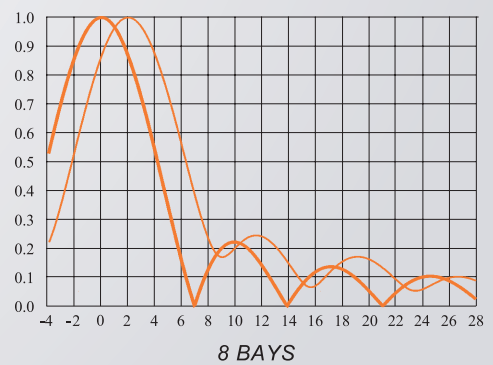
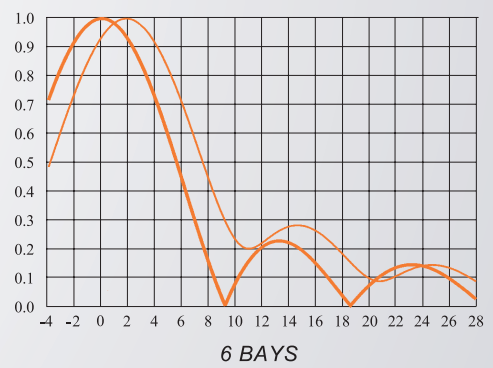
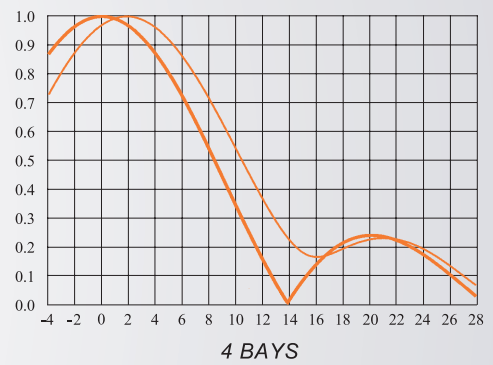
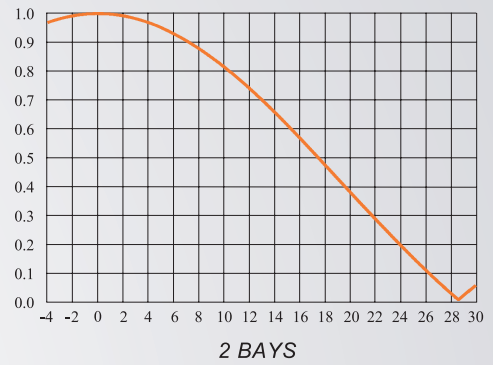

All dimensions are in millimeters (inches)